

CP1270Y (12V5.3Ah 5hr)

The rechargeable batteries are lead-lead dioxide systems. The dilute sulfuric acid electrolyte is absorbed by separators and plates and thus immobilized. Should the battery be accidentally overcharged producing hydrogen and oxygen, special one-way valves allow the gases to escape thus avoiding excessive pressure build-up. Otherwise, the battery is completely sealed and is, therefore, maintenance-free, leak proof and usable in any position.

Construction

Component	Positive plate	Negative plate	Container	Cover	Safety valve	Terminal	Separator	Electrolyte
Raw material	Lead dioxide	Lead	ABS	ABS	Rubber	Copper	Fiberglass	Sulfuric acid

General Features

- Absorbent Glass Mat (AGM) technology for efficient gas recombination of up to 99% and freedom from electrolyte maintenance or water adding.
- Not restricted for air transport-complies with IATA/ICAO Special Provision A67.
- UL-recognized component.
- Can be mounted in any orientation.
- Computer designed lead, calcium tin alloy grid for high power density.
- Long service life, float or cyclic applications.
- Maintenance-free operation.
- Low self discharge.
- Case and cover available in both standard and flame retardant ABS.

Dimensions and Weight

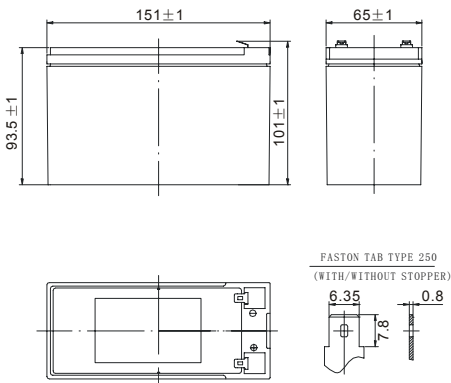

Technology Parameter

Battery model	CP1270Y		
nominal voltage	12V		
Number of cell	6		
Capacity (25°C)	5hR (1.06A, 10.5V)	3hR (1.63A, 10.5V)	1hR (4.15A, 9.6V)
	5.3Ah	4.89Ah	4.15Ah
Dimensions	Length	Width	Height
	151±1mm	65±1mm	93.5±1mm
Approx. weight	2.04Kg (4.49 lbs)		
Internal resistance	Full charged at 25°C: 21mOhms		
Self discharge	3% of capacity declined per month at 20°C (average)		
Operating temperature range	Discharge	Charge	Storage
	-20~60°C	-10~60°C	-20~60°C
Max. discharge current (25°C)	105A (5s)		
Short circuit current	380A		

Discharge ratings-amperes at 25°C(77°F)

End Point Volts/Cell	5min	10min	15min	30min	1h	3h	5h
1.60V	28.3	18.1	13.9	8.18	4.15	1.80	1.12
1.65V	26.8	17.3	13.4	7.86	4.05	1.75	1.10
1.70V	25.3	16.4	12.9	7.51	3.93	1.69	1.08
1.75V	23.8	15.5	12.3	7.15	3.79	1.63	1.06
1.80V	22.2	14.6	11.7	6.75	3.64	1.56	1.04

Discharge ratings-watts per cell at 25°C(77°F)

End Point Volts/Cell	5min	10min	15min	30min	45min	1h	2h	3h	5h
1.60V	51.0	34.5	25.8	14.9	11.20	8.70	4.98	3.50	2.26
1.65V	48.6	32.8	25.0	14.4	10.80	8.37	4.87	3.41	2.23
1.70V	46.1	31.1	24.1	13.8	10.40	8.03	4.74	3.32	2.19
1.75V	43.5	29.4	23.1	13.2	9.98	7.78	4.59	3.22	2.14
1.80V	40.8	27.6	22.0	12.6	9.55	7.43	4.44	3.11	2.08

(Note)The above characteristics data are average values obtained within three charge/discharge cycles not the minimum values.



VISION

CP1270Y 12V5.3Ah

Vision Rechargeable Products

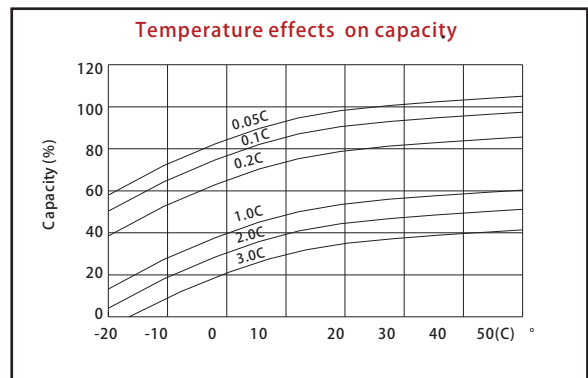
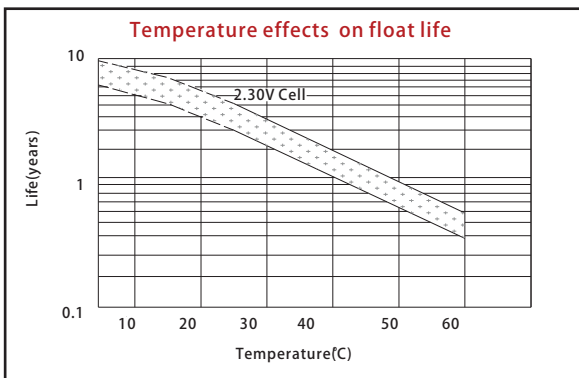
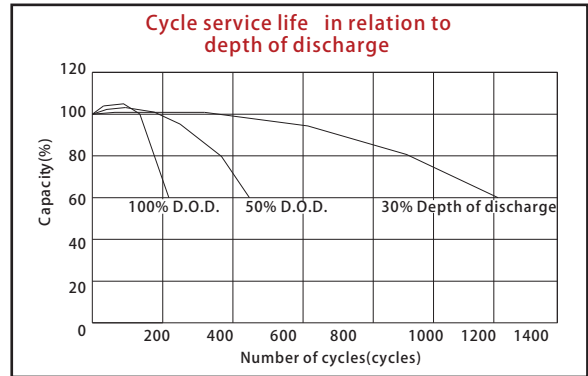
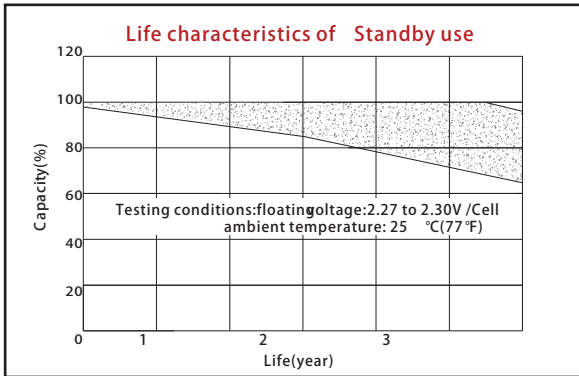
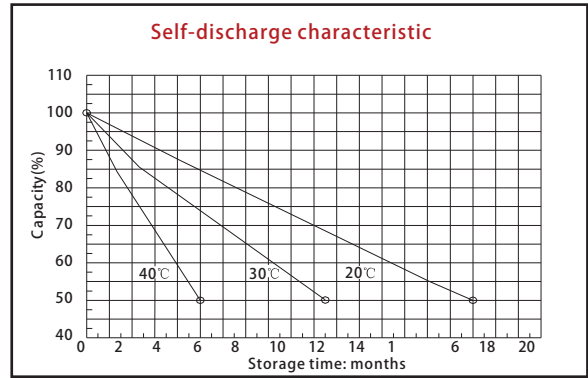
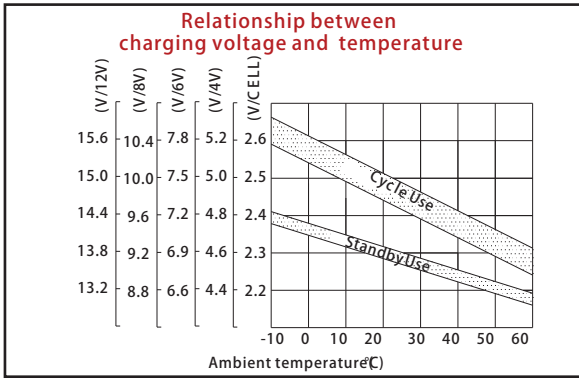
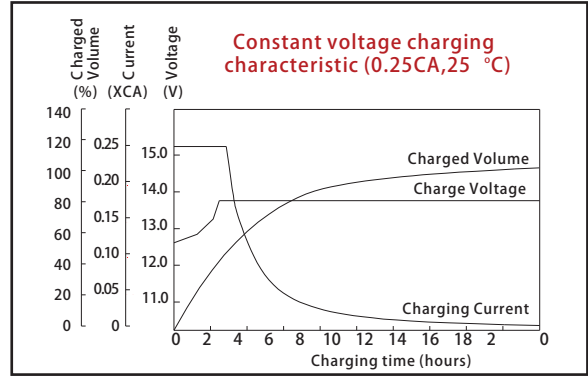
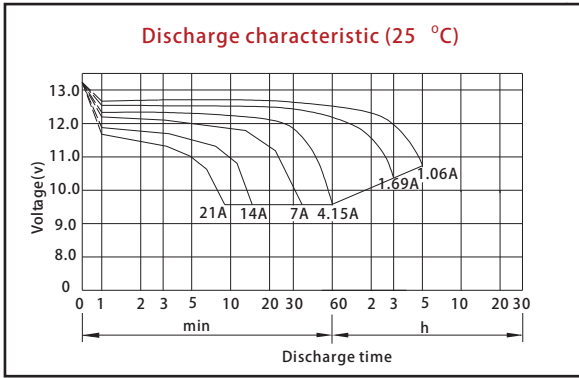

Shenzhen Center Power Tech. Co., Ltd.
 Center Power Industrial Park, Tongfu Industrial District Dapeng Town,
 518120 Shenzhen, China
 Tel: +86-755-8431 8088 Fax: +86-755-8431 8038
 Email: sales@vision-batt.com

